

Mounting instruction

Sliding door

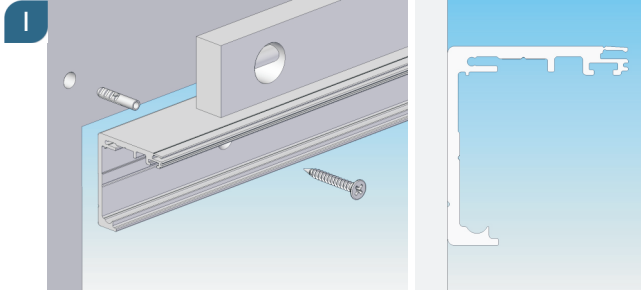

Checking the glass height, then calculating and positioning the height of screw holes on wall or ceiling. Drilling the screw holes (8mm) on the wall or ceiling, ensure the screw holes are in line, you can use level for assistance. Using a 7mm drill bit to drill through the non-through holes on rail frame. Then inserting suitable anchors (8mm) to the holes, fixing the rail frame to the wall or ceiling with M6 tapping screws, and ensuring the rail is firmly fixed.

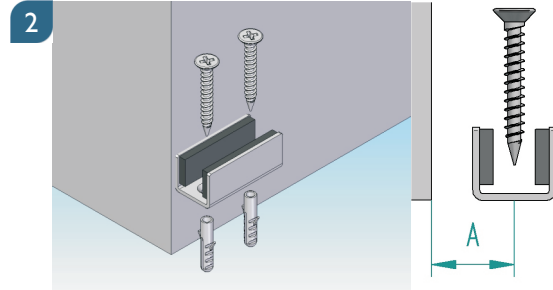

Before installing the door guides, first checking the glass thickness for determining distance "A" (center of door guide to wall)

A = 21,5 mm at 8 mm glass

22,5 mm at 10 mm glass

then drilling appropriate holes on the ground, inserting suitable anchors then tightening screws to fix the door guides. If the rail frame is screwed to the ceiling, distance "A" measures is from the center of door guides to the outside edge of rail frame.

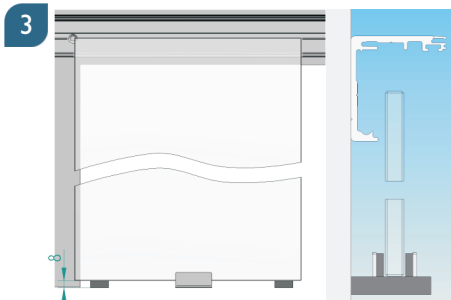

Placing the glass door inside door guide, lifting up the glass door 8mm from the ground by placing 2pcs of blocks on both end of the glass door.

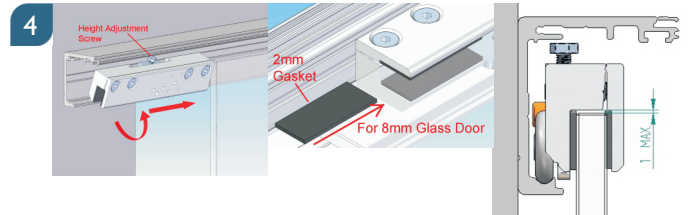

Slide in carriages from both rail ends or tilting the carriages about 20 degrees to place the rollers onto the track groove, before straightening the carriage to slide over glass door top, the distance between glass top and inside of carriage can not exceed 1mm, if distance is incorrect, slide the carriages out of glass door, and turning the height adjustment screw by hand, then repeat previous step to ensure distance do not exceed 1mm. When glass thickness is 8mm, adding 2pcs of 2mm gaskets to each carriage, 1pc to the right and 1pc to the left to fill-in the gap between glass door and carriage.

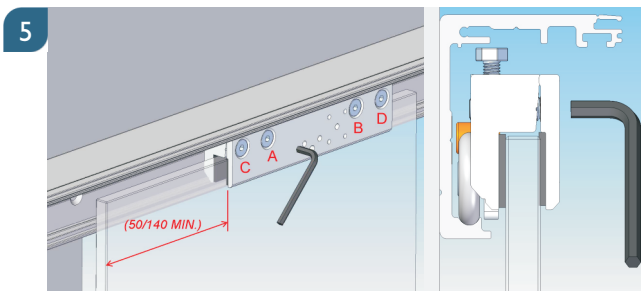

Adjusting the left-hand and right-hand carriage to the proper distance measuring from the glass door edge, if installing stopper, the distance should be minimum 50mm, if installing soft closing mechanism, the distance should be minimum 140mm.

Once the position of carriage is determined, using 4mm hexagon wrench to tighten the 4 screws on carriage in the order of ABCD as marked on above drawing, tightening torque for the screws is 12N.M.

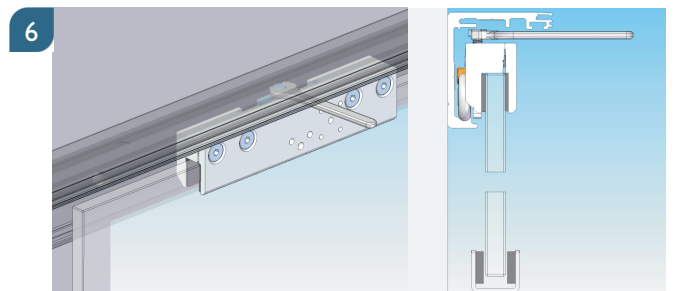

Using 8mm wrench to evenly turn the height adjustment screw on both left-hand and right-hand carriage in order to lift up the glass door, then removing the blocks underneath glass door, and slightly adjust the door height if necessary.

INSTALLING STOPPER, PLS. SKIP STEPS 8-11.

INSTALLING SOFT CLOSING MECHANISM, PLS. SKIP STEP 7.

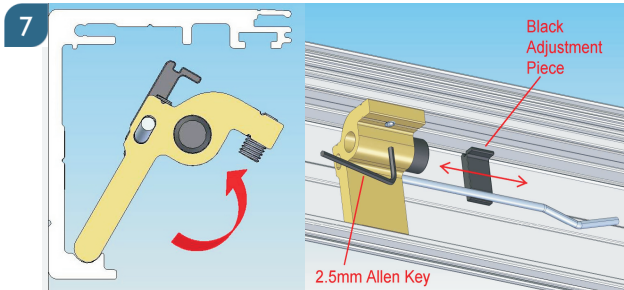

Tilting the round bottom of stopper onto the track groove before straightening the stopper, using a 2.5mm hexagon wrench to slightly tighten the screw on top, then fitting the black adjustment piece groove to the track, and click in with stopper spring. Sliding the glass door to the left-hand and right-hand stopper to ensure the door stopping position is correct, if not, loosening the stopper screw to adjust the position of stopper, then tightening the screw to fix the stopper in correct position. Afterwards, adjusting the door holding force by moving the black adjustment piece sideways, until the desired force is reached.

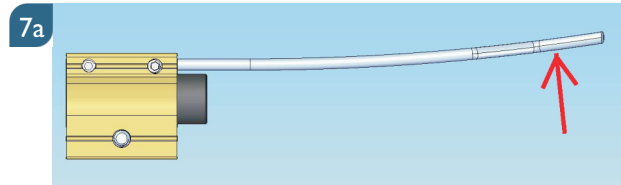

If the stopper spring is rubbing against the carriage, it may be the result of uneven wall, pls. take out the stopper, and bending the spring in the arrow direction to make it slightly curved (as shown above), then re-installing the stopper.

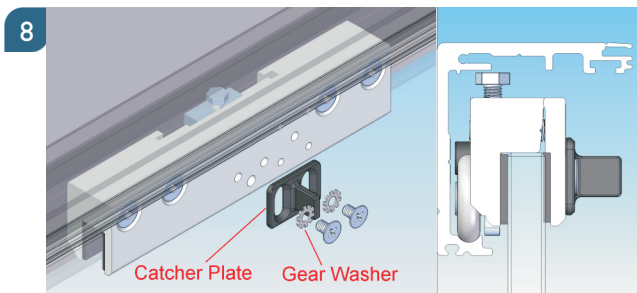

Before installing the soft closing mechanism, fix the catcher plate onto carriage with two screws, but do not yet tighten both screws, because the catcher plate may require height adjustment in later steps.

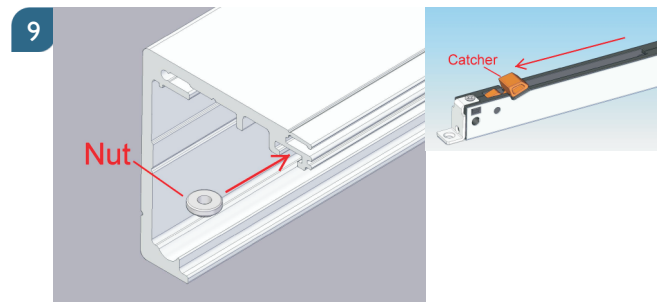

Placing the 4pcs of screw nuts (taken from accessory bag) inside the front groove of rail frame per top drawing above, 2pcs each side left and right. Take the soft closing mechanism and pushing the catcher to the front "catching position" per bottom drawing above.

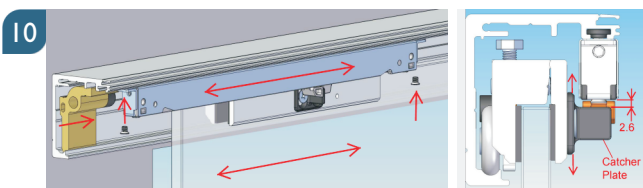

Using 2pcs of M4X5L screws to temporarily fix the soft closing mechanism inside the front groove of rail frame, before tightening the screws, pls. move the 4 screw nuts (already put inside the front groove of rail in step 9) to fit with the 4 screws for fixing left-hand and right-hand soft closing mechanism. Then adjusting the height of catcher plate fixed on the carriage in step 8, keeping a distance of 2.6mm between the top of catcher plate and bottom of soft closing mechanism (as per above drawing). Slide the glass door until catcher plate falls into the catcher of soft closing mechanism and smoothly pulls the glass door to the end holding position of mechanism. Slightly loosen the 2pcs of screws to bring the glass door together with left-hand or right-hand soft closing mechanism to the predetermined door stopping position, then tightening the screw to fix the soft closing mechanism.

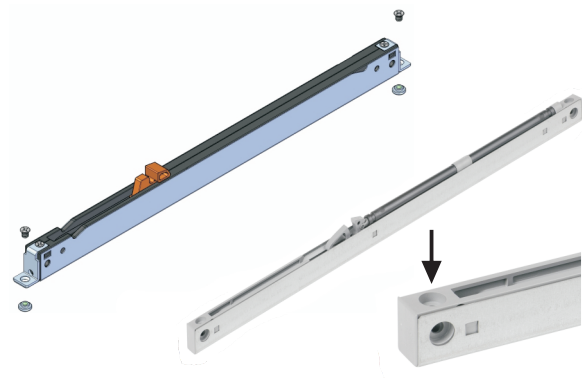

Please note that we have two different variants of soft close. The oil- pressure damper (top figure) is shown as fixed with the M4X5L bolt to the profile. If you use the air-pressure damper (lower figure) use the longer M4X19L screws through the damper profil.

Mounting instruction

Slidingdoor

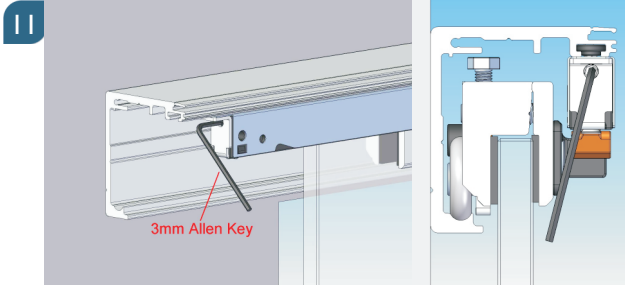

Sliding the glass door again to test the soft closing mechanism, and ensuring the strength of mechanism can pull the door smoothly to the end holding position, if not, will need to adjust the spring pulling force. Using a 3mm hexagon wrench to turn clock-wise the adjustment screw at one end of the soft closing mechanism until spring pulling force is strong enough to pull the door to end holding position. Soft closing mechanism is assembled with standard pulling force for 40kgs door weight, turning the screw clock-wise 15 circles for 60kgs door weight, and max. 30 circles clock-wise for 80kgs door weight.

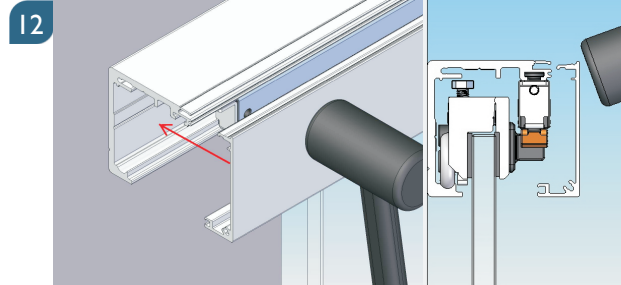

Placing the rail front cover onto the rail frame by using rubber hammer, ensuring the front cover is firmly clicked into rail frame, unable to move or take out easily.

Optional you can use side-panels, follow the following assembly steps A - C.

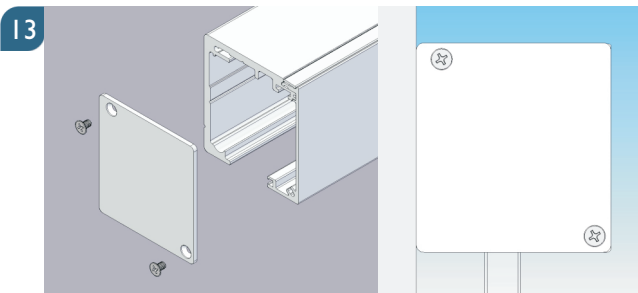

Placing left-hand and right-hand end cap respectively on each side of rail, and fixing it with 2pcs of M3 screws.

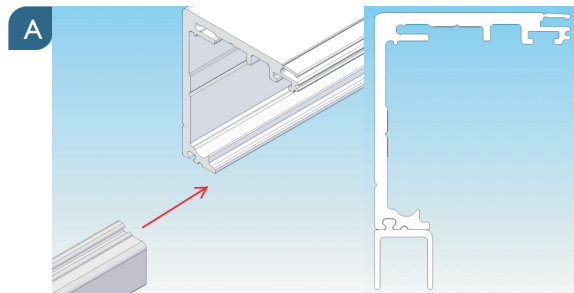

Cutting the U shape aluminum profile to fit the actual length of fix panel glass, and sliding the aluminum profile into rail frame from the side.

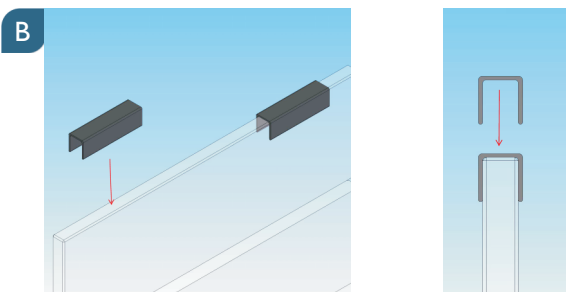

Placing the U shape gaskets on glass top at appropriate position on each end, pls. pay attention to the two different gasket sizes for 8mm and 10mm glass thickness.

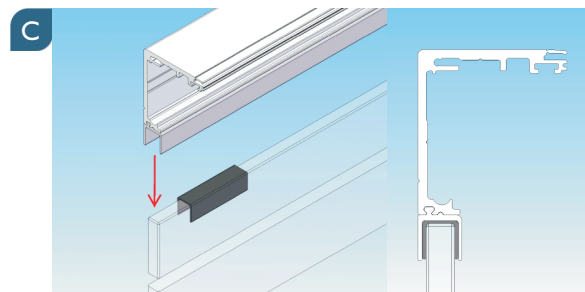

Lastly, placing the rail frame already installed with U shape profile, putting it over the fix panel glass from top down (installation on bottom is the same as on top)

Synchro - Accessory Kit (optional)

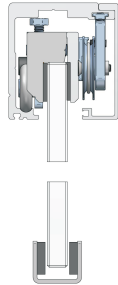
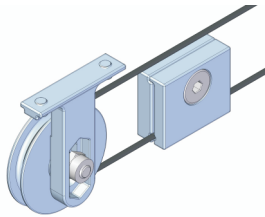

The guide roller is inserted in the profile, screwed with the clamped and is so infinitely adjustable in the profile.

An additional height adjustment of the roller guarantees a smooth running. The two plates can adjust on the standard carriage. The wire rope needs to be clamped in the clamp once below and once above and needs to be led around the pulleys. The system is fully integrated in the rail and thus mounted invisible.

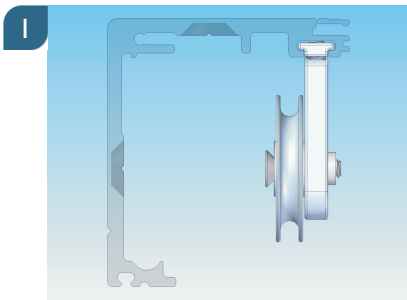

1 installation guide pulley

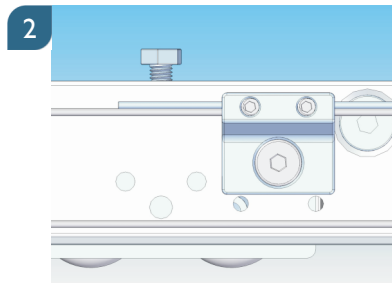

2 1 x Clamping oriented upward

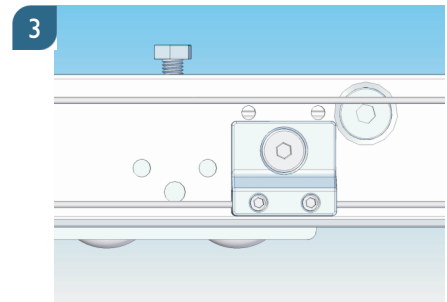

3 1 x Clamping oriented downward

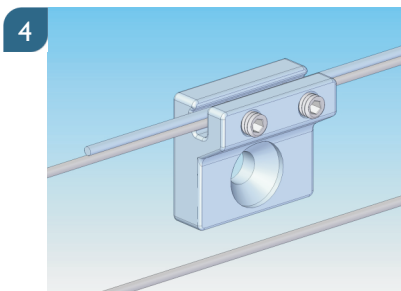

4 The end of the cable Connection get fixed in a clamp

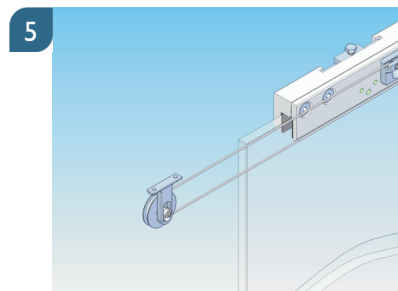

5 Synchro - Set assembled

Mounting instruction

Slidingdoor

Installation situation without self-closing glass door

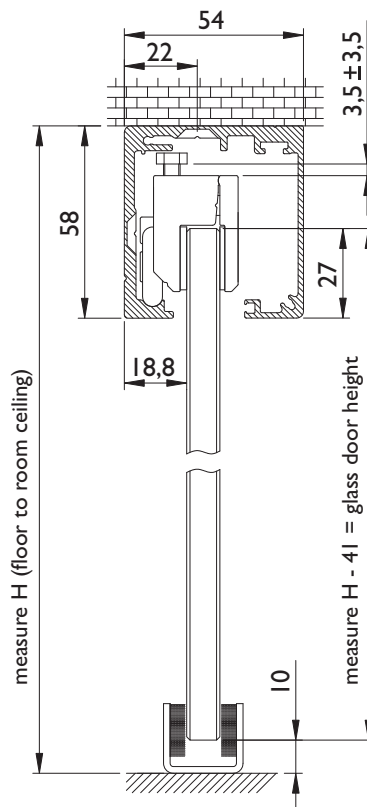
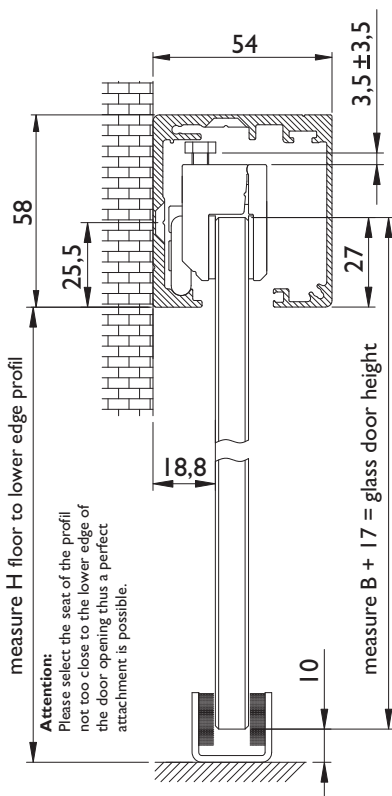
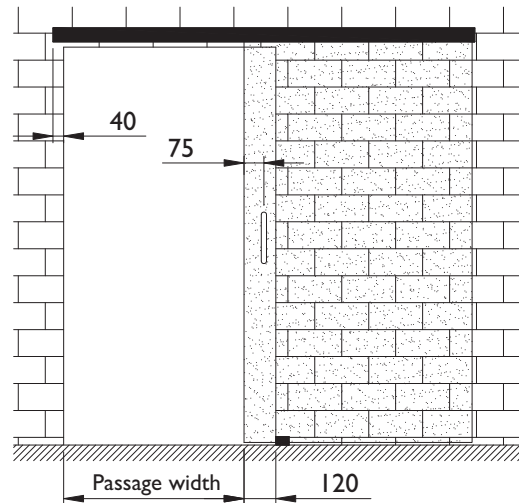
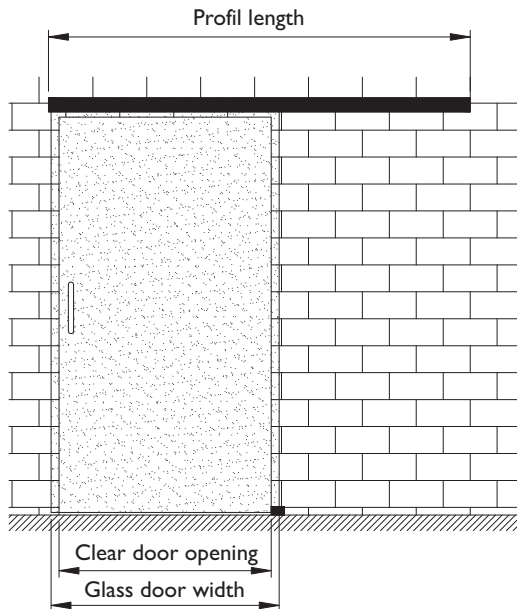

Glass door width:
clear door opening + 60 mm

Glass door height:
wall mounting = measure B + 17 mm
ceiling mounting = measure H - 41 mm

Profil length:
(door width x 2) - 10

Passage width:
clear door opening - 120 mm

Profil length 2000 mm:
max. clear door opening 1005 mm

Profil length 2400 mm:
max. clear door opening 1205 mm

Capacity:
mounting-set:
mit 2 carriage = 80 kg
mit 4 carriage = 120 kg



The specified door - supernatants are indicative so they can adapted to the structural conditions.

Installation situation with self-closing glass door

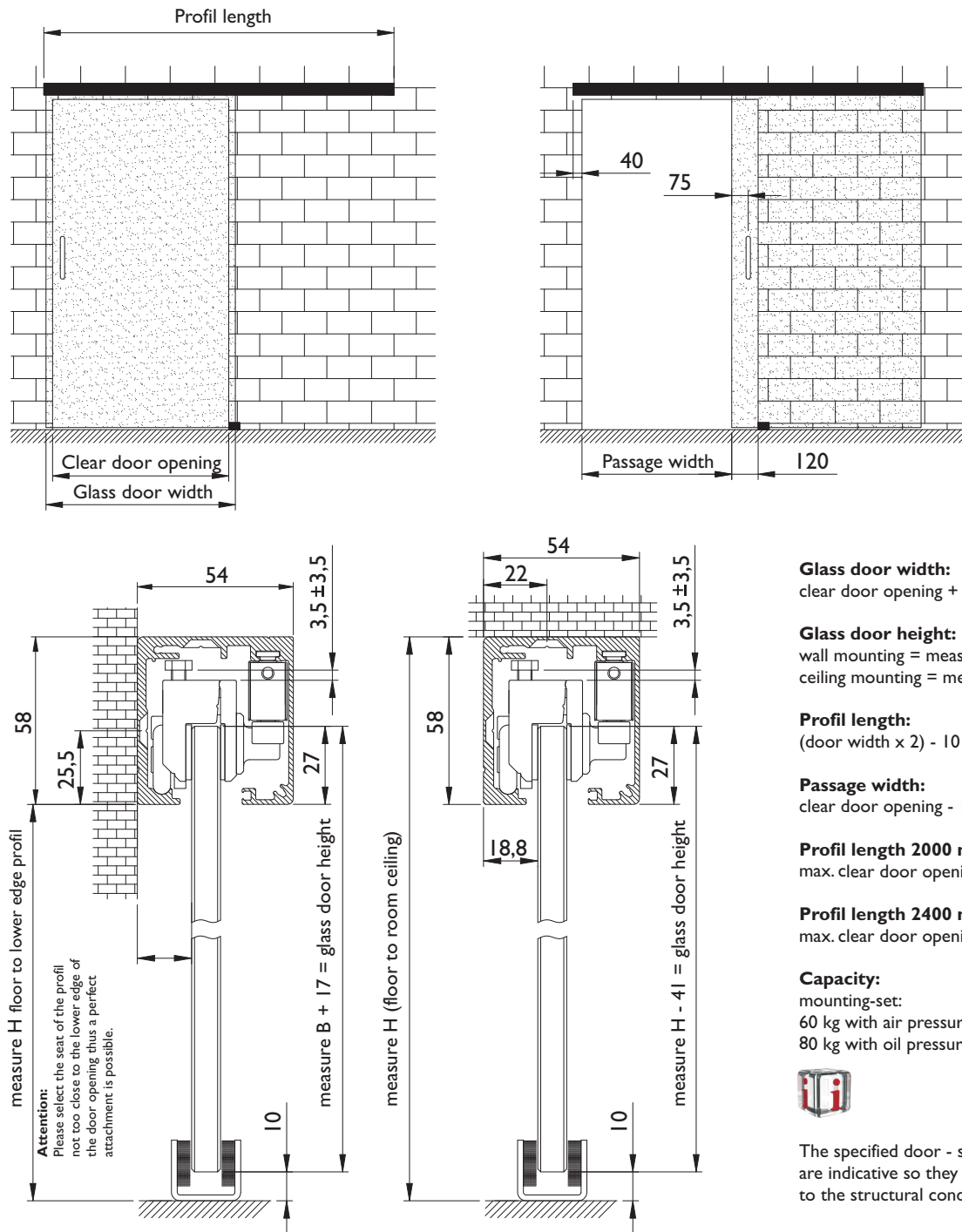

The calculated minimum width when the self-feeder's version is 540 mm.
 Calculated Minimum rail length is 960 mm. The glass door won't close flush with the profil.
 We recommend a minimum door width of 750 mm if you use a self-closing.
 Most users feel disturbed by the effort needed to close small doors from the catchment damper,



The specified door - supernatants are indicative so they can be adapted to the structural conditions.

Mounting instruction

Slidingdoor

Installation situation without self-closing wood door

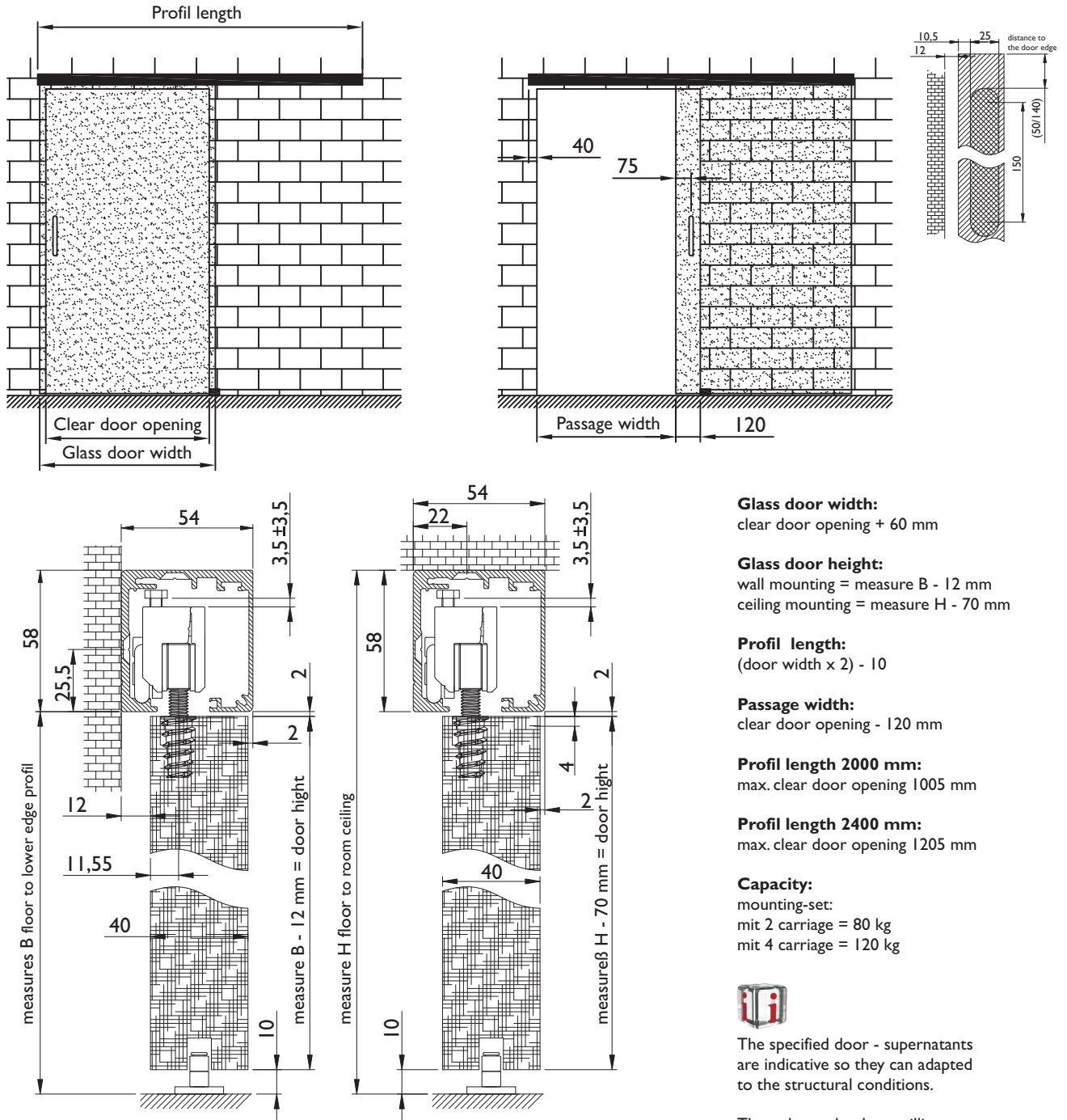

Glass door width:
clear door opening + 60 mm

Glass door height:
wall mounting = measure B - 12 mm
ceiling mounting = measure H - 70 mm

Profil length:
(door width x 2) - 10

Passage width:
clear door opening - 120 mm

Profil length 2000 mm:
max. clear door opening 1005 mm

Profil length 2400 mm:
max. clear door opening 1205 mm

Capacity:
mounting-set:
mit 2 carriage = 80 kg
mit 4 carriage = 120 kg



The specified door - supernatants are indicative so they can adapted to the structural conditions.

Through put the door milling towards the wall also the wall-distance can be increased. The distance to the edge of door 50 mm is a minimum. Depending on Installation situation, the distance can be divergent.

Installation situation with self-closing wood door

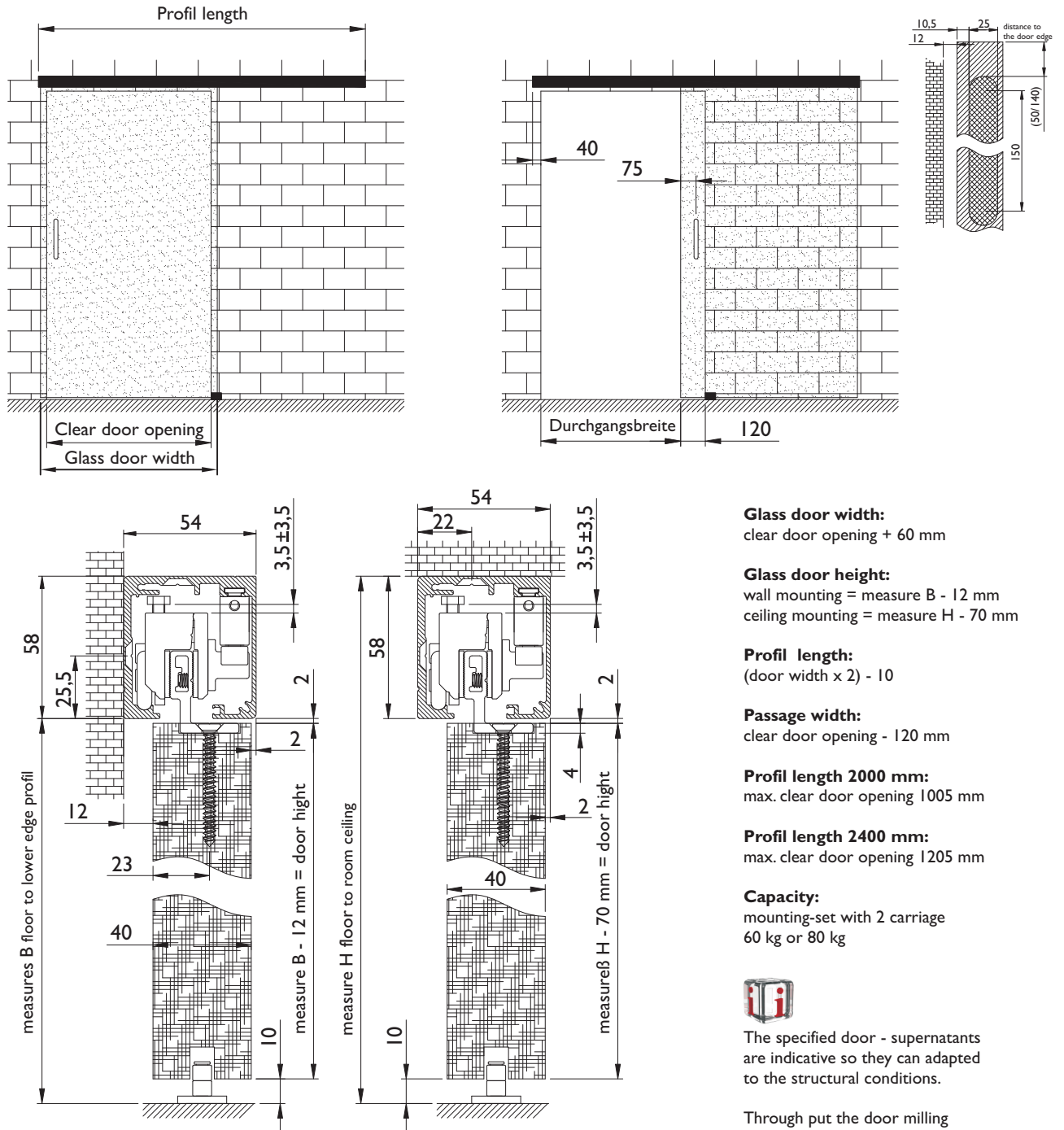

Glass door width:
clear door opening + 60 mm

Glass door height:
wall mounting = measure B - 12 mm
ceiling mounting = measure H - 70 mm

Profile length:
(door width x 2) - 10

Passage width:
clear door opening - 120 mm

Profile length 2000 mm:
max. clear door opening 1005 mm

Profile length 2400 mm:
max. clear door opening 1205 mm

Capacity:
mounting-set with 2 carriage
60 kg or 80 kg



The specified door - supernatans are indicative so they can adapted to the structural conditions.

Through put the door milling towards the wall also the wall-distance can be increased. The distance to the edge of door 140 mm is a minimum. Depending on Installation situation, the distance can be increased.

Mounting instruction

Slidingdoor

Additional profile for door side panel

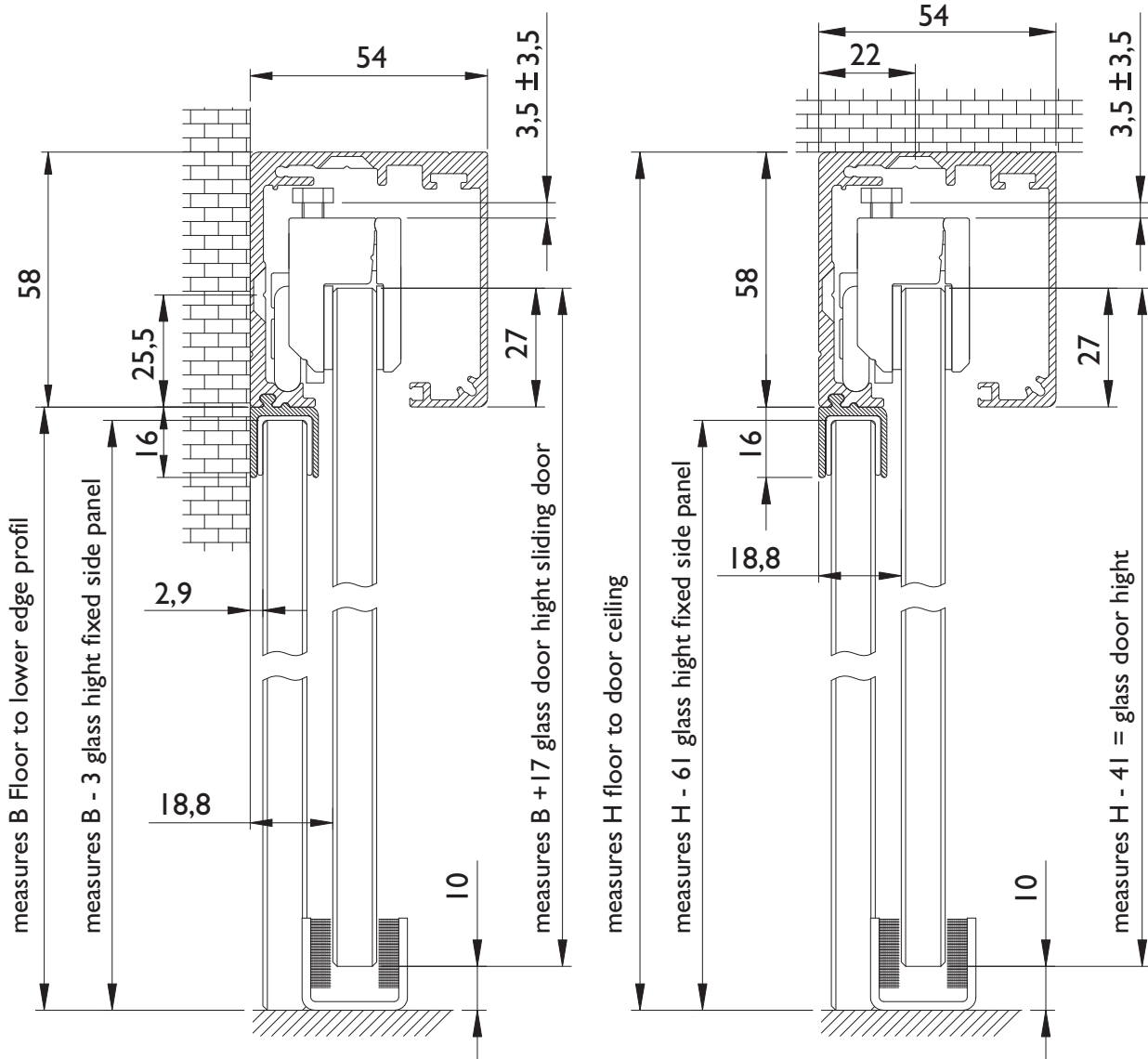

Please note that all for specifications on the glass hight we assume that the glass side panels ends right on the floor. If you use extra profiles and chocks they need to considered in the calculation.